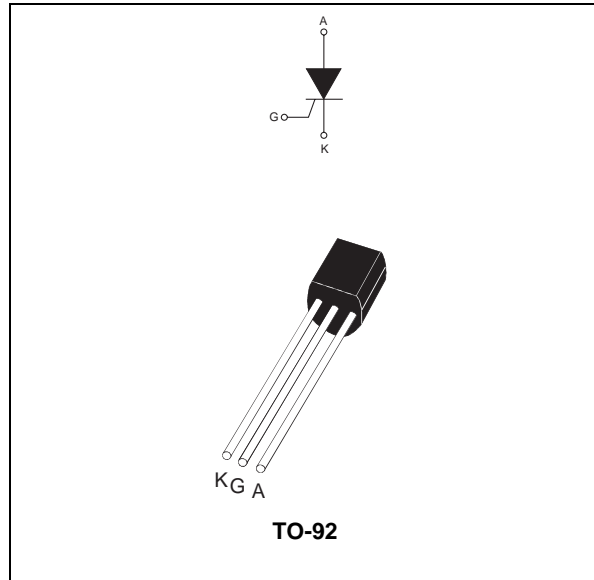


**MAIN FEATURES:**

| Symbol            | Value | Unit    |
|-------------------|-------|---------|
| $I_{T(RMS)}$      | 0.8   | A       |
| $V_{DRM}/V_{RRM}$ | 600   | V       |
| $I_{GT}$          | 200   | $\mu A$ |

**DESCRIPTION**

Thanks to highly sensitive triggering levels, the X006 SCR series is suitable for all applications where the available gate current is limited, such as ground fault circuit interrupters, overvoltage crowbar protection in low power supplies, capacitive ignition circuits, ...



**ABSOLUTE RATINGS** (limiting values)

| Symbol             | Parameter  |                        | Value                          | Unit       |
|--------------------|--|------------------------|--------------------------------|------------|
| $I_{T(RMS)}$       | RMS on-state current (180° conduction angle)   |                        | $T_I = 85^\circ C$<br>0.8      | A          |
| $I_{T(AV)}$        | Average on-state current (180° conduction angle)   |                        | $T_I = 85^\circ C$<br>0.5      | A          |
| $I_{TSM}$          | Non repetitive surge peak on-state current   | $t_p = 8.3 \text{ ms}$ | $T_j = 25^\circ C$<br>10       | A          |
|                    |  | $t_p = 10 \text{ ms}$  |                                |            |
| $I^2t$             | $I^2t$ Value for fusing  | $t_p = 10 \text{ ms}$  | $T_j = 25^\circ C$<br>0.25     | $A^2S$     |
| $di/dt$            | Critical rate of rise of on-state current<br>$I_G = 2 \times I_{GT}$ , $t_r \leq 100 \text{ ns}$ | $F = 60 \text{ Hz}$    | $T_j = 125^\circ C$<br>50      | $A/\mu s$  |
| $I_{GM}$           | Peak gate current  | $t_p = 20 \mu s$       | $T_j = 125^\circ C$<br>1       | A          |
| $P_{G(AV)}$        | Average gate power dissipation   |                        | $T_j = 125^\circ C$<br>0.1     | W          |
| $T_{stg}$<br>$T_j$ | Storage junction temperature range<br>Operating junction temperature range                       |                        | - 40 to + 125<br>- 40 to + 125 | $^\circ C$ |

## X00602MA

### ELECTRICAL CHARACTERISTICS (T<sub>j</sub> = 25°C, unless otherwise specified)

| Symbol                               | Test Conditions   |                        | X00602MA | Unit |    |
|--------------------------------------|---|------------------------|----------|------|----|
| I <sub>GT</sub>                      | V <sub>D</sub> = 12 V    R <sub>L</sub> = 140 Ω   | MIN.                   | 15       | μA   |    |
|                                      |   | MAX.                   | 200      | μA   |    |
| V <sub>GT</sub>                      |   | MAX.                   | 0.8      | V    |    |
| V <sub>GD</sub>                      | V <sub>D</sub> = V <sub>DRM</sub> R <sub>L</sub> = 3.3 kΩ    R <sub>GK</sub> = 1 kΩ    T <sub>j</sub> = 125°C | MIN.                   | 0.2      | V    |    |
| V <sub>RG</sub>                      | I <sub>RG</sub> = 10 μA   | MIN.                   | 5        | V    |    |
| I <sub>H</sub>                       | I <sub>T</sub> = 50 mA    R <sub>GK</sub> = 1 kΩ  | MAX.                   | 5        | mA   |    |
| I <sub>L</sub>                       | I <sub>G</sub> = 1 mA    R <sub>GK</sub> = 1 kΩ   | MAX.                   | 6        | mA   |    |
| dV/dt                                | V <sub>D</sub> = 67 % V <sub>DRM</sub> R <sub>GK</sub> = 1 kΩ    T <sub>j</sub> = 125°C                       | MIN.                   | 25       | V/μs |    |
| V <sub>TM</sub>                      | I <sub>TM</sub> = 1 A    t <sub>p</sub> = 380 μs    T <sub>j</sub> = 25°C                                     | MAX.                   | 1.35     | V    |    |
| V <sub>th0</sub>                     | Threshold voltage    T <sub>j</sub> = 125°C   | MAX.                   | 0.85     | V    |    |
| R <sub>d</sub>                       | Dynamic resistance    T <sub>j</sub> = 125°C  | MAX.                   | 245      | mΩ   |    |
| I <sub>DRM</sub><br>I <sub>RRM</sub> | V <sub>DRM</sub> = V <sub>RRM</sub> R <sub>GK</sub> = 1 kΩ  | T <sub>j</sub> = 25°C  | MAX.     | 1    | μA |
|                                      |   | T <sub>j</sub> = 125°C |          | 100  |    |

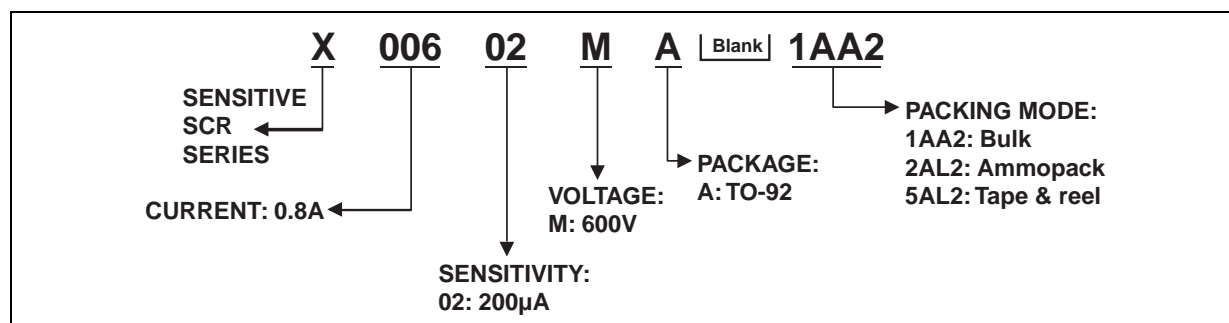
### THERMAL RESISTANCES

| Symbol               | Parameter                | Value | Unit |
|----------------------|--------------------------|-------|------|
| R <sub>th(j-l)</sub> | Junction to lead (DC)    | 70    | °C/W |
| R <sub>th(j-a)</sub> | Junction to ambient (DC) | 150   | °C/W |

### PRODUCT SELECTOR

| Part Number | Voltage | Sensitivity | Package |
|-------------|---------|-------------|---------|
| X00602MA    | 600 V   | 200 μA      | TO-92   |

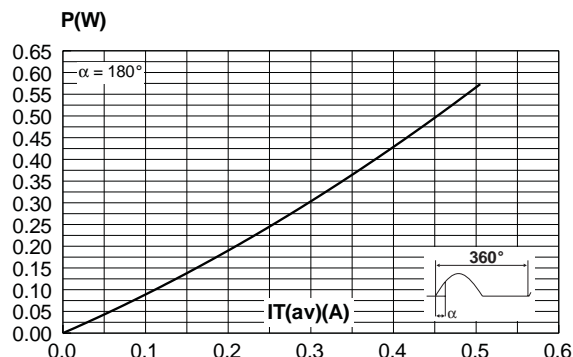
### ORDERING INFORMATION



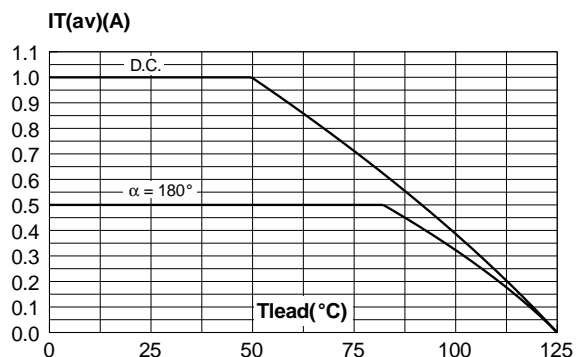
### OTHER INFORMATION

| Part Number   | Marking | Weight | Base Quantity | Packing mode |
|---------------|---------|--------|---------------|--------------|
| X00602MA 1AA2 | X0602MA | 0.2 g  | 2500          | Bulk         |
| X00602MA 2AL2 | X0602MA | 0.2 g  | 2000          | Ammopack     |
| X00602MA 5AL2 | X0602MA | 0.2 g  | 2000          | Tape & reel  |

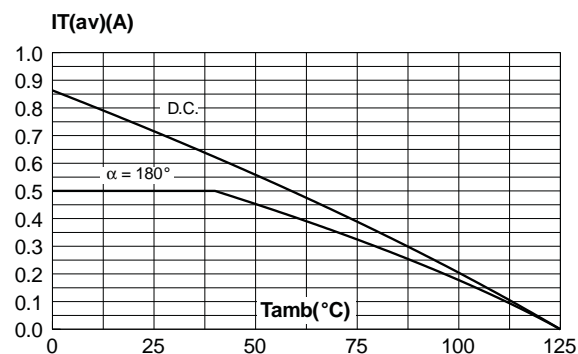
**Fig. 1:** Maximum average power dissipation versus average on-state current.



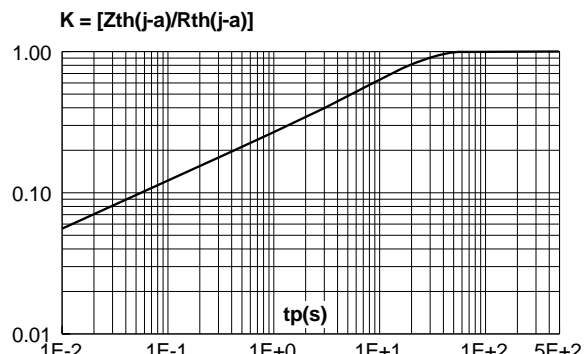
**Fig. 2-1:** Average and D.C. on-state current versus lead temperature.



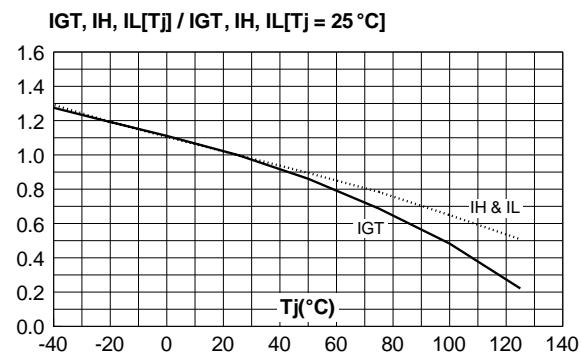
**Fig. 2-2:** Average and D.C. on-state current versus ambient temperature (device mounted on FR4 with recommended pad layout).



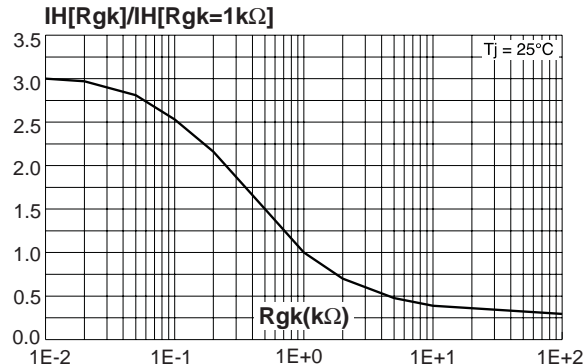
**Fig. 3:** Relative variation of thermal impedance junction to ambient versus pulse duration.



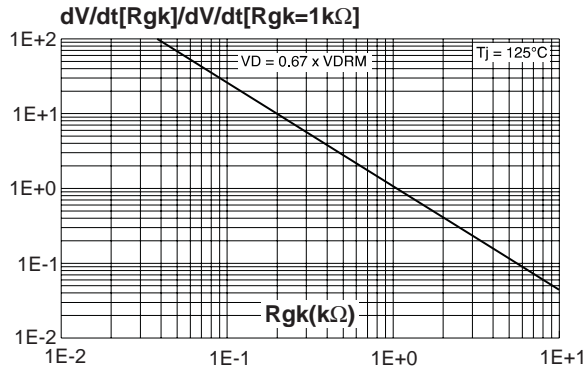
**Fig. 4:** Relative variation of gate trigger current, holding current and latching current versus junction temperature.



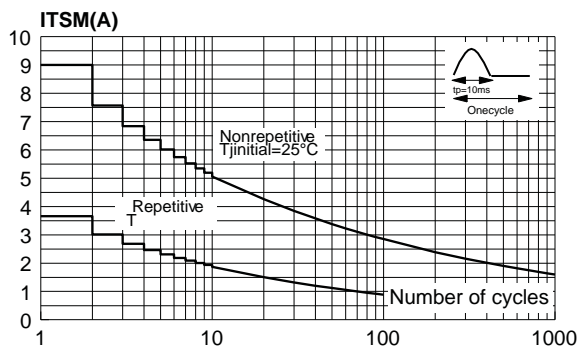
**Fig. 5:** Relative variation of holding current versus gate-cathode resistance (typical values).



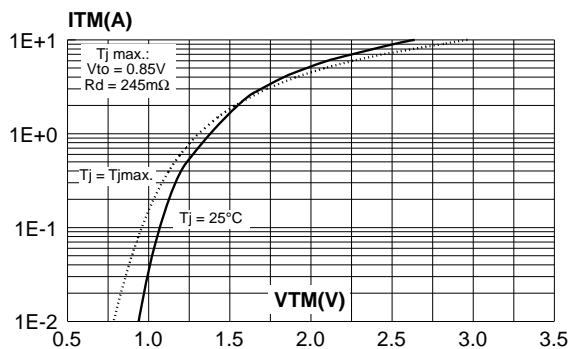
**Fig. 6:** Relative variation of dV/dt immunity versus gate-cathode resistance (typical values).



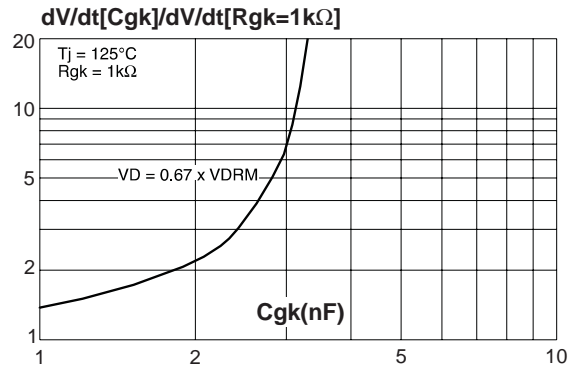
**Fig. 8:** Surge peak on-state current versus number of cycles.



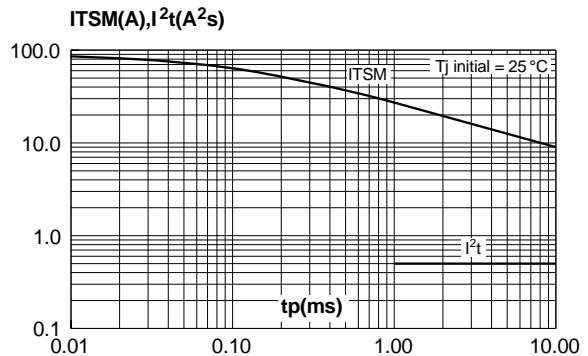
**Fig. 10:** On-state characteristics (maximum values).



**Fig. 7:** Relative variation of dV/dt immunity versus gate-cathode capacitance (typical values).

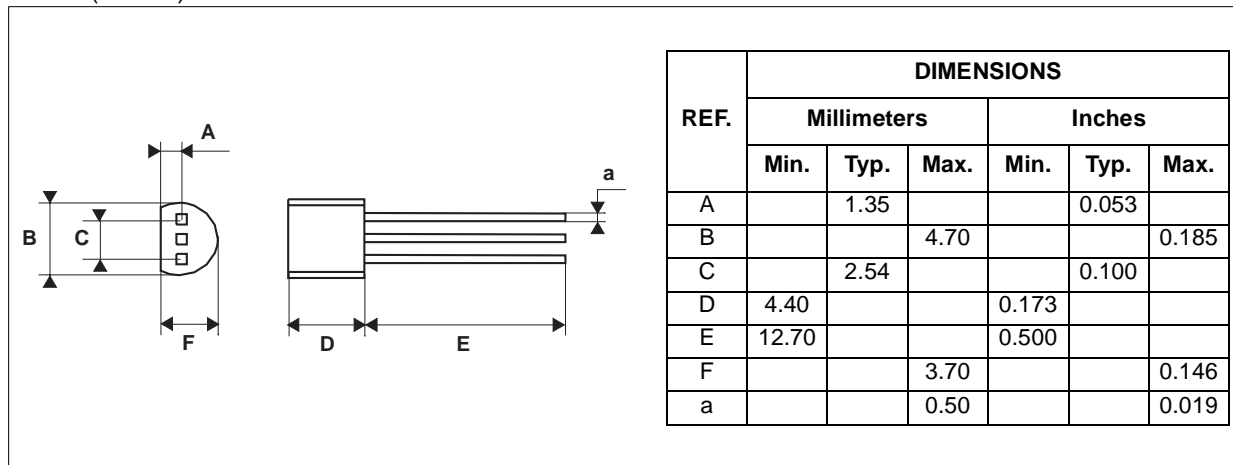


**Fig. 9:** Non-repetitive surge peak on-state current for a sinusoidal pulse with width  $tp < 10$  ms, and corresponding value of  $I^2t$ .



## PACKAGE MECHANICAL DATA

TO-92 (Plastic)



Information furnished is believed to be accurate and reliable. However, STMicroelectronics assumes no responsibility for the consequences of use of such information nor for any infringement of patents or other rights of third parties which may result from its use. No license is granted by implication or otherwise under any patent or patent rights of STMicroelectronics. Specifications mentioned in this publication are subject to change without notice. This publication supersedes and replaces all information previously supplied. STMicroelectronics products are not authorized for use as critical components in life support devices or systems without express written approval of STMicroelectronics.

© The ST logo is a registered trademark of STMicroelectronics

© 2002 STMicroelectronics - Printed in Italy - All Rights Reserved

STMicroelectronics GROUP OF COMPANIES  
 Australia - Brazil - Canada - China - Finland - France - Germany  
 Hong Kong - India - Israel - Italy - Japan - Malaysia - Malta - Morocco - Singapore  
 Spain - Sweden - Switzerland - United Kingdom - United States

<http://www.st.com>